

6

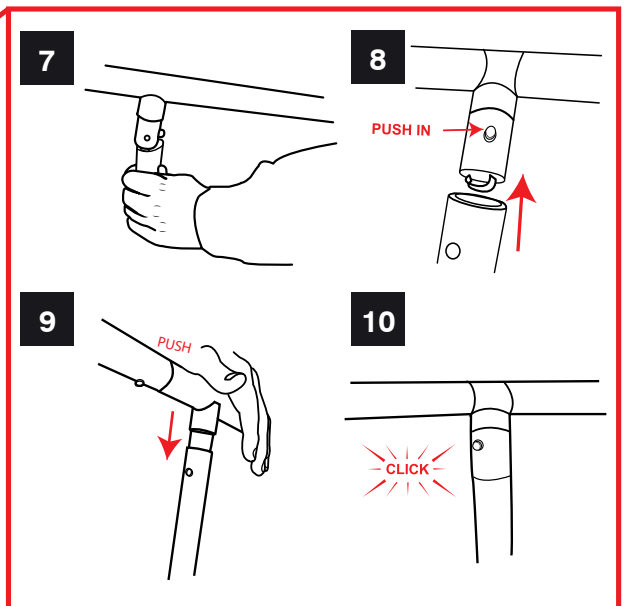

NOTA: ALINEAR POLOS CON CONECTORES

11

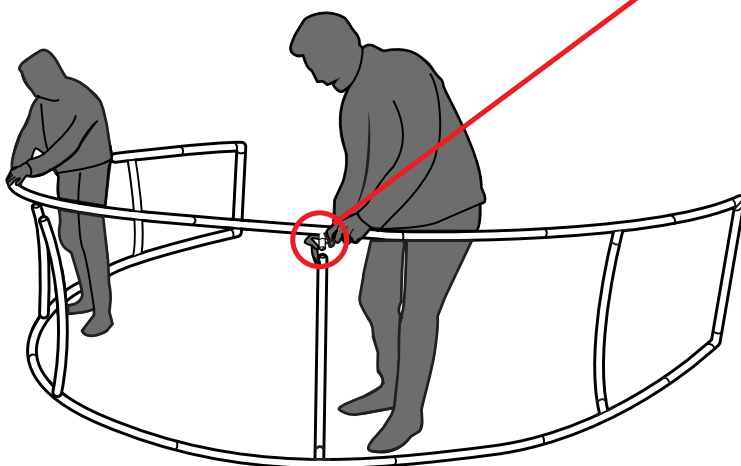
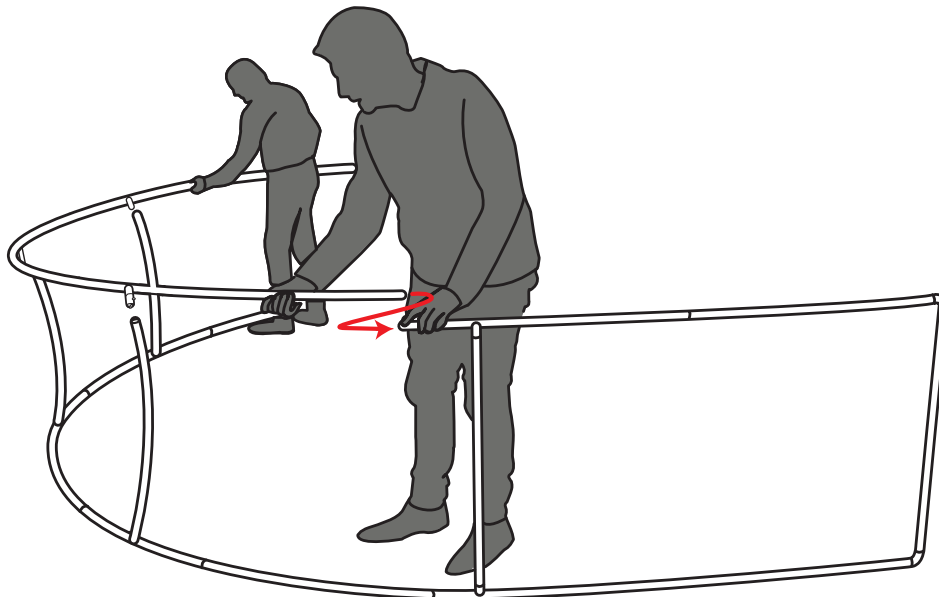
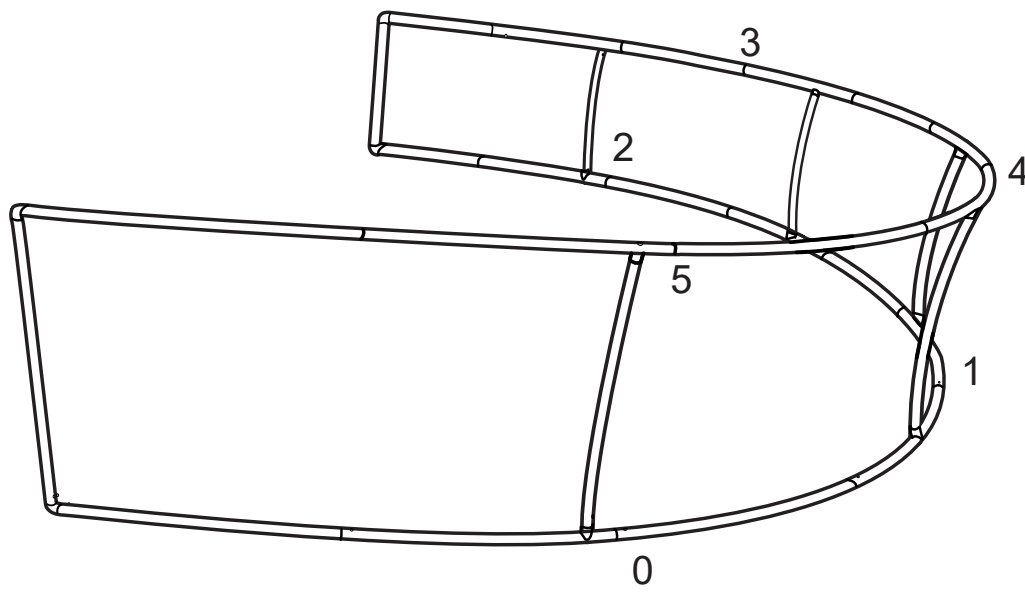



1

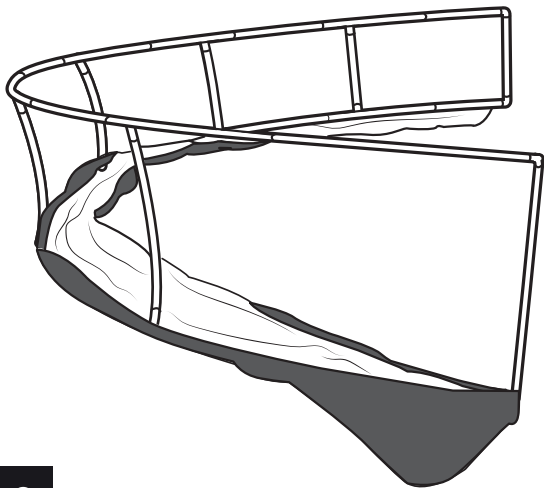

2

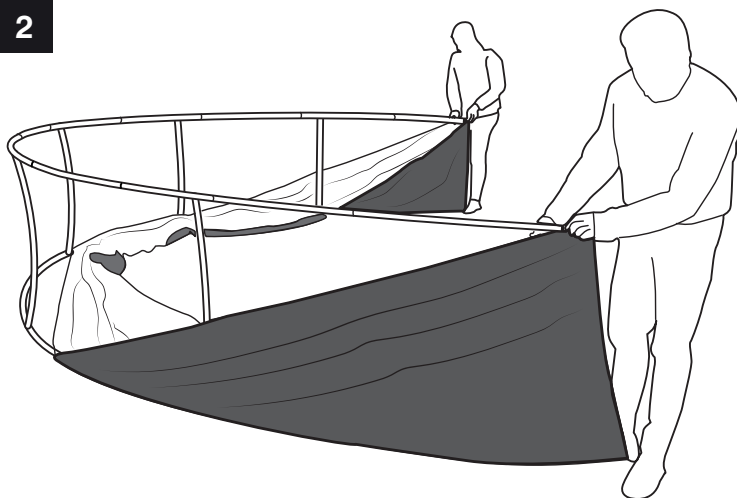

3

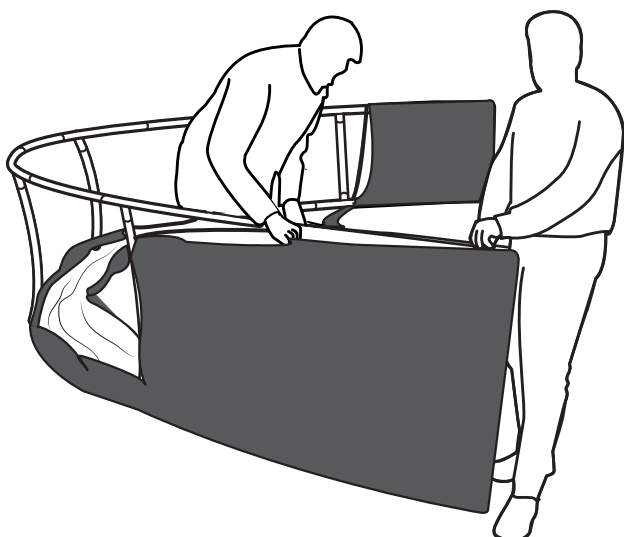

4

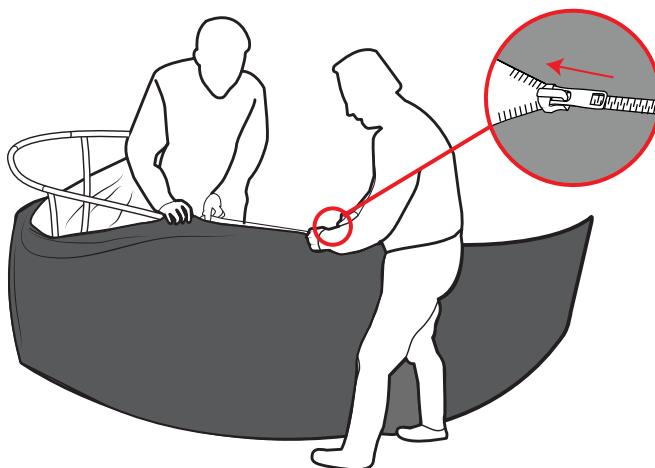

5

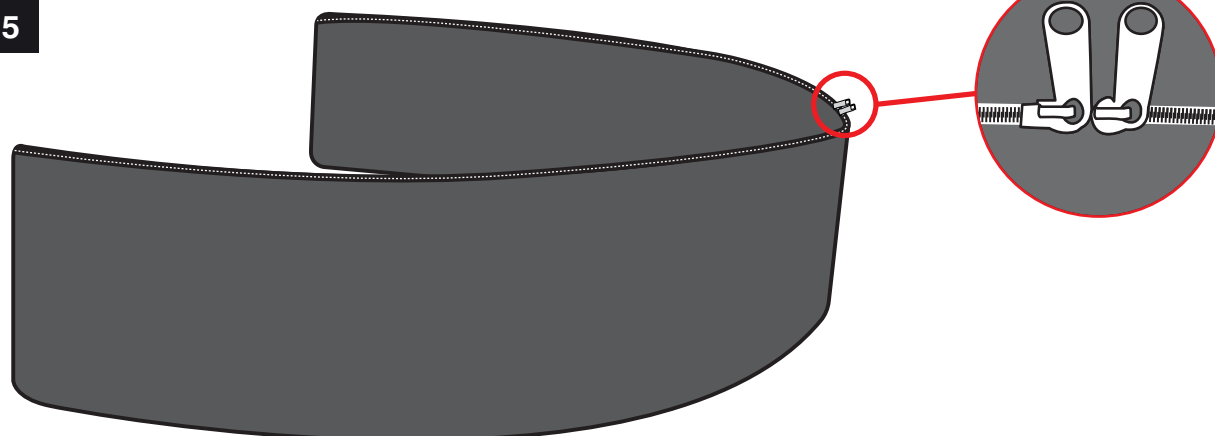

1

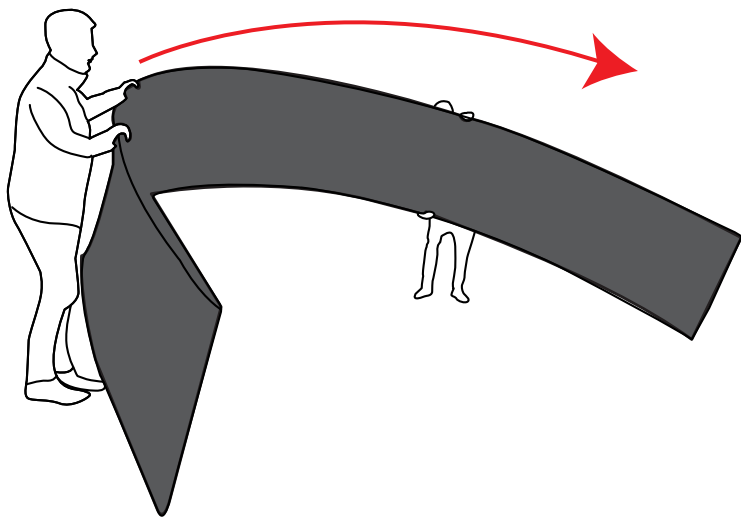

2

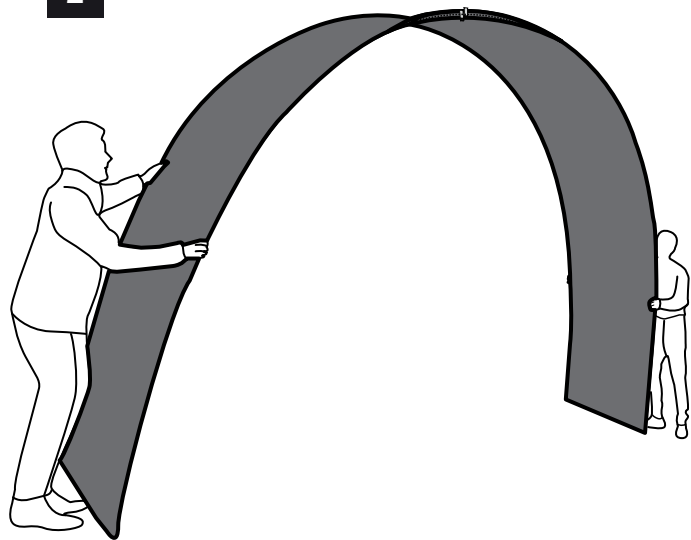

3

